

Very Low Noise, Differential Amplifier and 2.5MHz Lowpass Filter

FEATURES

- $\pm 0.6\text{dB}$ (Max) Ripple 4th Order Lowpass Filter with 2.5MHz Cutoff
- Programmable Differential Gain via Two External Resistors
- Adjustable Output Common Mode Voltage
- Operates and Specified with 3V, 5V, $\pm 5\text{V}$ Supplies
- 86dB S/N with 3V Supply and 1V_{RMS} Output
- Low Distortion, 1V_{RMS} , 800Ω Load
1MHz: 95dBc 2nd, 88dBc 3rd
- Fully Differential Inputs and Outputs
- Compatible with Popular Differential Amplifier Pinouts
- SO-8 and DFN-12 Packages

APPLICATIONS

- High Speed ADC Antialiasing and DAC Smoothing in Networking or Cellular Basestation Applications
- High Speed Test and Measurement Equipment
- Medical Imaging
- Drop-in Replacement for Differential Amplifiers

LT, LT, LTC, LTM, Linear Technology and the Linear logo are registered trademarks of Linear Technology Corporation. All other trademarks are the property of their respective owners.

DESCRIPTION

The LT[®]6600-2.5 combines a fully differential amplifier with a 4th order 2.5MHz lowpass filter approximating a Chebyshev frequency response. Most differential amplifiers require many precision external components to tailor gain and bandwidth. In contrast, with the LT6600-2.5, two external resistors program differential gain, and the filter's 2.5MHz cutoff frequency and passband ripple are internally set. The LT6600-2.5 also provides the necessary level shifting to set its output common mode voltage to accommodate the reference voltage requirements of A/Ds.

Using a proprietary internal architecture, the LT6600-2.5 integrates an antialiasing filter and a differential amplifier/driver without compromising distortion or low noise performance. At unity gain the measured in band signal-to-noise ratio is an impressive 86dB. At higher gains the input referred noise decreases so the part can process smaller input differential signals without significantly degrading the output signal-to-noise ratio.

The LT6600-2.5 also features low voltage operation. The differential design provides outstanding performance for a $4\text{V}_{\text{P-P}}$ signal level while the part operates with a single 3V supply. The LT6600-2.5 is available in SO-8 and DFN-12 packages.

For similar devices with higher cutoff frequency, refer to the LT6600-5, LT6600-10, LT6600-15 and LT6600-20 data sheets.

TYPICAL APPLICATION (S8 Pin Numbers Shown)

DAC Output Filter

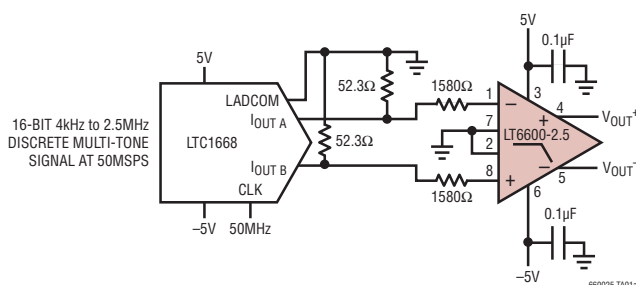

DAC Output Spectrum

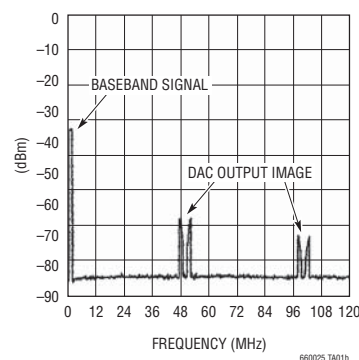

LT6600-2.5 Output Spectrum

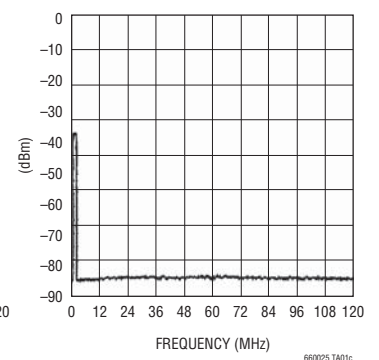

LT6600-2.5

ABSOLUTE MAXIMUM RATINGS (Note 1)

Total Supply Voltage	11V	Junction Temperature	150°C
Input Current (Note 8).....	±10mA	Storage Temperature Range.....	-65°C to 150°C
Operating Temperature Range (Note 6)....	-40°C to 85°C	Lead Temperature (Soldering, 10 sec)	300°C
Specified Temperature Range (Note 7)	-40°C to 85°C		

PIN CONFIGURATION



ORDER INFORMATION

LEAD FREE FINISH	TAPE AND REEL	PART MARKING*	PACKAGE DESCRIPTION	SPECIFIED TEMPERATURE RANGE
LT6600CS8-2.5#PBF	LT6600CS8-2.5#TRPBF	660025	8-Lead Plastic SO	0°C to 70°C
LT6600IS8-2.5#PBF	LT6600IS8-2.5#TRPBF	600125	8-Lead Plastic SO	-40°C to 85°C
LT6600CDF-2.5#PBF	LT6600CDF-2.5#TRPBF	60025	12-Lead (4mm × 4mm) Plastic DFN	0°C to 70°C
LT6600IDF-2.5#PBF	LT6600IDF-2.5#TRPBF	60025	12-Lead (4mm × 4mm) Plastic DFN	-40°C to 85°C
LEAD BASED FINISH	TAPE AND REEL	PART MARKING	PACKAGE DESCRIPTION	SPECIFIED TEMPERATURE RANGE
LT6600CS8-2.5	LT6600CS8-2.5#TR	660025	8-Lead Plastic SO	0°C to 70°C
LT6600IS8-2.5	LT6600IS8-2.5#TR	600125	8-Lead Plastic SO	-40°C to 85°C

Consult LTC Marketing for parts specified with wider operating temperature ranges.

*The temperature grade is identified by a label on the shipping container for the DFN Package.

Consult LTC Marketing for information on nonstandard lead based finish parts.

For more information on lead free part marking, go to: <http://www.linear.com/leadfree/>

For more information on tape and reel specifications, go to: <http://www.linear.com/tapeandreel/>

ELECTRICAL CHARACTERISTICS

The ● denotes the specifications which apply over the full operating temperature range, otherwise specifications are at T_A = 25°C. Unless otherwise specified V_S = 5V (V⁺ = 5V, V⁻ = 0V), R_{IN} = 1580Ω, and R_{LOAD} = 1k.

PARAMETER	CONDITIONS	MIN	TYP	MAX	UNITS
Filter Gain, V _S = 3V	V _{IN} = 2V _{P-P} , f _{IN} = DC to 260kHz	-0.5	0.1	0.4	dB
R _{IN} = 1580Ω	V _{IN} = 2V _{P-P} , f _{IN} = 700kHz (Gain Relative to 260kHz)	● -0.15	0	0.1	dB
	V _{IN} = 2V _{P-P} , f _{IN} = 1.9MHz (Gain Relative to 260kHz)	● -0.2	0.2	0.6	dB
	V _{IN} = 2V _{P-P} , f _{IN} = 2.2MHz (Gain Relative to 260kHz)	● -0.6	0.1	0.5	dB

660025fe

ELECTRICAL CHARACTERISTICS The ● denotes the specifications which apply over the full operating temperature range, otherwise specifications are at $T_A = 25^\circ\text{C}$. Unless otherwise specified $V_S = 5\text{V}$ ($V^+ = 5\text{V}$, $V^- = 0\text{V}$), $R_{IN} = 1580\Omega$, and $R_{LOAD} = 1\text{k}$.

PARAMETER	CONDITIONS	MIN	TYP	MAX	UNITS	
	$V_{IN} = 2V_{P-P}$, $f_{IN} = 2.5\text{MHz}$ (Gain Relative to 260kHz)	● -2.1	-0.9	0	dB	
	$V_{IN} = 2V_{P-P}$, $f_{IN} = 7.5\text{MHz}$ (Gain Relative to 260kHz)	●	-34	-31	dB	
	$V_{IN} = 2V_{P-P}$, $f_{IN} = 12.5\text{MHz}$ (Gain Relative to 260kHz)	●	-51		dB	
Filter Gain, $V_S = 5\text{V}$	$V_{IN} = 2V_{P-P}$, $f_{IN} = \text{DC to } 260\text{kHz}$	-0.5	-0.1	0.4	dB	
$R_{IN} = 1580\Omega$	$V_{IN} = 2V_{P-P}$, $f_{IN} = 700\text{kHz}$ (Gain Relative to 260kHz)	● -0.15	0	0.1	dB	
	$V_{IN} = 2V_{P-P}$, $f_{IN} = 2.2\text{MHz}$ (Gain Relative to 260kHz)	● -0.2	0.2	0.6	dB	
	$V_{IN} = 2V_{P-P}$, $f_{IN} = 2.2\text{MHz}$ (Gain Relative to 260kHz)	● -0.6	0.1	0.5	dB	
	$V_{IN} = 2V_{P-P}$, $f_{IN} = 2.5\text{MHz}$ (Gain Relative to 260kHz)	● -2.1	-0.9	0	dB	
	$V_{IN} = 2V_{P-P}$, $f_{IN} = 7.5\text{MHz}$ (Gain Relative to 260kHz)	●	-34	-31	dB	
	$V_{IN} = 2V_{P-P}$, $f_{IN} = 12.5\text{MHz}$ (Gain Relative to 260kHz)	●	-51		dB	
Filter Gain, $V_S = \pm 5\text{V}$	$V_{IN} = 2V_{P-P}$, $f_{IN} = \text{DC to } 260\text{kHz}$	-0.6	-0.1	0.4	dB	
Filter Gain, $R_{IN} = 402\Omega$	$V_{IN} = 0.5V_{P-P}$, $f_{IN} = \text{DC to } 260\text{kHz}$, $V_S = 3\text{V}$	11.3	11.8	12.3	dB	
	$V_{IN} = 0.5V_{P-P}$, $f_{IN} = \text{DC to } 260\text{kHz}$, $V_S = 5\text{V}$	11.3	11.8	12.3	dB	
	$V_{IN} = 0.5V_{P-P}$, $f_{IN} = \text{DC to } 260\text{kHz}$, $V_S = \pm 5\text{V}$	11.2	11.7	12.2	dB	
Filter Gain Temperature Coefficient (Note 2)	$f_{IN} = 260\text{kHz}$, $V_{IN} = 2V_{P-P}$		780		ppm/ $^\circ\text{C}$	
Noise	Noise BW = 10kHz to 2.5MHz		51		μV_{RMS}	
Distortion (Note 4)	1MHz, $1V_{\text{RMS}}$, $R_L = 800\Omega$		95		dBc	
	2nd Harmonic		88		dBc	
	3rd Harmonic					
Differential Output Swing	Measured Between Pins 4 and 5				$V_{P-P \text{ DIFF}}$	
	$V_S = 5\text{V}$	● 8.8	9.3			
	$V_S = 3\text{V}$	● 5.1	5.5		$V_{P-P \text{ DIFF}}$	
Input Bias Current	Average of Pin 1 and Pin 8	● -35	-15		μA	
Input Referred Differential Offset	$R_{IN} = 1580\Omega$, Differential Gain = 1V/V	●	5	25	mV	
	$V_S = 3\text{V}$	●	5	30	mV	
	$V_S = 5\text{V}$	●	5	35	mV	
	$V_S = \pm 5\text{V}$	●				
	$R_{IN} = 402\Omega$, Differential Gain = 4V/V	●	3	13	mV	
	$V_S = 3\text{V}$	●	3	16	mV	
	$V_S = 5\text{V}$	●	3	20	mV	
	$V_S = \pm 5\text{V}$	●				
Differential Offset Drift			10		$\mu\text{V}/^\circ\text{C}$	
Input Common Mode Voltage (Note 3)	Differential Input = 500mV _{P-P} , $R_{IN} \geq 402\Omega$	●	0.0	1.5	V	
	$V_S = 3\text{V}$	●	0.0	3.0	V	
	$V_S = 5\text{V}$	●	-2.5	1.0	V	
	$V_S = \pm 5\text{V}$	●				
Output Common Mode Voltage (Note 5)	Differential Input = 2V _{P-P} , Pin 7 = Open	●	1.0	1.5	V	
	$V_S = 3\text{V}$	●	1.5	3.0	V	
	$V_S = 5\text{V}$	●	-1.0	2.0	V	
	$V_S = \pm 5\text{V}$	●				
Output Common Mode Offset (with Respect to Pin 2)		●	-25	10	45	mV
	$V_S = 3\text{V}$	●	-30	5	45	mV
	$V_S = 5\text{V}$	●	-55	-10	35	mV
	$V_S = \pm 5\text{V}$	●				
Common Mode Rejection Ratio			63		dB	
Voltage at V_{MID} (Pin 7)		●	2.46	2.51	2.55	V
	$V_S = 5\text{V}$ (S8)	●	2.45	2.51	2.56	V
	$V_S = 5\text{V}$ (DFN)	●		1.5		V
	$V_S = 3\text{V}$	●				
V_{MID} Input Resistance		●	4.3	5.7	7.7	k Ω
V_{OCM} Bias Current	$V_{OCM} = V_{MID} = V_S/2$	●	-15	-3		μA
	$V_S = 5\text{V}$	●	-10	-3		μA
	$V_S = 3\text{V}$	●				
Power Supply Current		●		26	30	mA
	$V_S = 3\text{V}$, $V_S = 5\text{V}$	●			33	mA
	$V_S = 5\text{V}$, $V_S = 5\text{V}$	●				
	$V_S = \pm 5\text{V}$	●		28	36	mA

ELECTRICAL CHARACTERISTICS

Note 1: Stresses beyond those listed under Absolute Maximum Ratings may cause permanent damage to the device. Exposure to any Absolute Maximum Rating condition for extended periods may affect device reliability and lifetime.

Note 2: This is the temperature coefficient of the internal feedback resistors assuming a temperature independent external resistor (R_{IN}).

Note 3: The input common mode voltage is the average of the voltages applied to the external resistors (R_{IN}). Specification guaranteed for $R_{IN} \geq 402\Omega$. For $\pm 5V$ supplies, the minimum input common mode voltage is guaranteed by design to reach $-5V$.

Note 4: Distortion is measured differentially using a single-ended stimulus. The input common mode voltage, the voltage at V_{OCM} , and the voltage at V_{MID} are equal to one half of the total power supply voltage.

Note 5: Output common mode voltage is the average of the voltages at Pins 4 and 5. The output common mode voltage is equal to the voltage applied to Pin 2.

Note 6: The LT6600C-2.5 is guaranteed functional over the operating temperature range of $-40^{\circ}C$ to $85^{\circ}C$.

Note 7: The LT6600C-2.5 is guaranteed to meet specified performance from $0^{\circ}C$ to $70^{\circ}C$ and is designed, characterized and expected to meet specified performance from $-40^{\circ}C$ and $85^{\circ}C$, but is not tested or QA sampled at these temperatures. The LT6600I-2.5 is guaranteed to meet specified performance from $-40^{\circ}C$ to $85^{\circ}C$.

Note 8: The inputs are protected by back-to-back diodes. If the differential input voltage exceeds $1.4V$, the input current should be limited to less than $10mA$.

TYPICAL PERFORMANCE CHARACTERISTICS

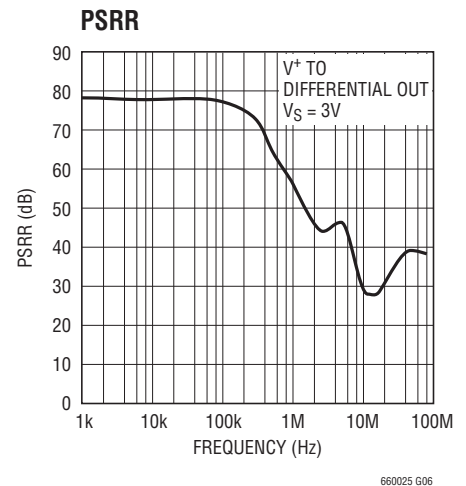
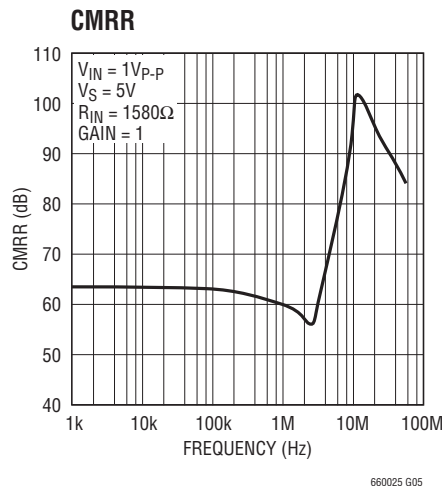
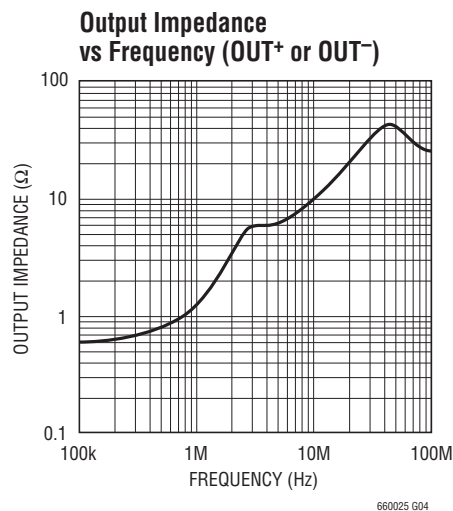
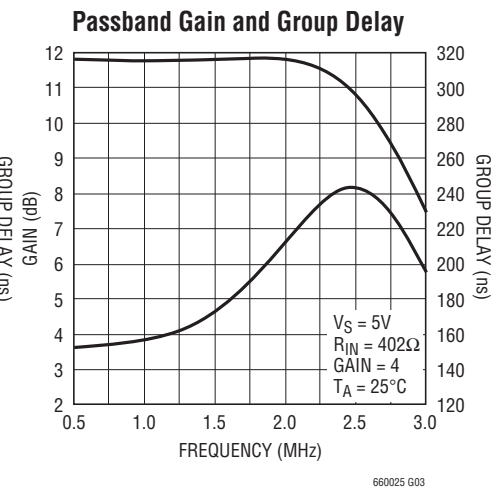
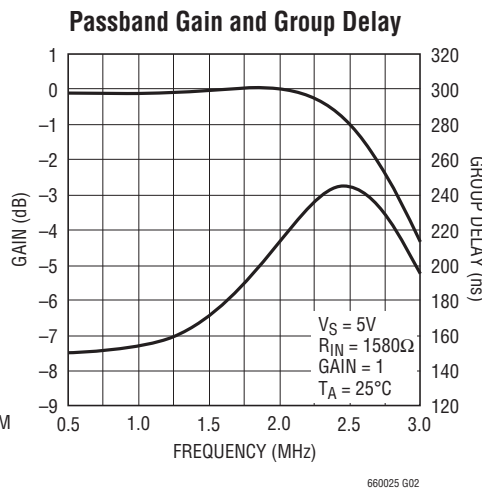
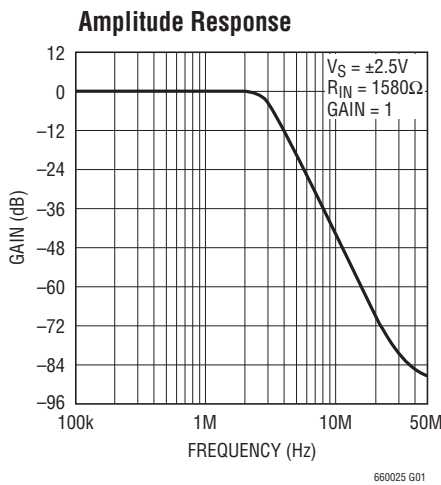

TYPICAL PERFORMANCE CHARACTERISTICS

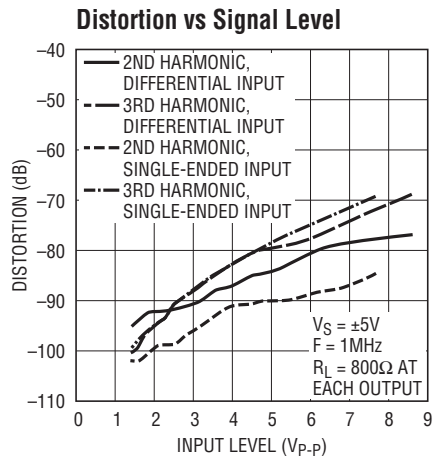
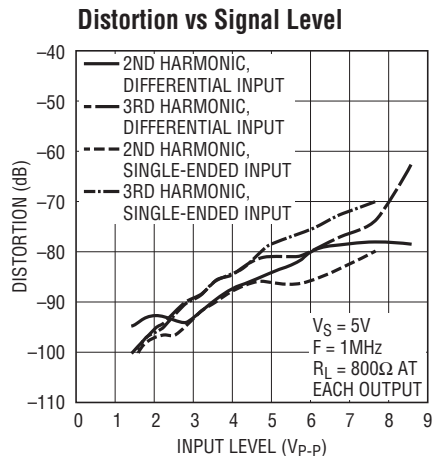
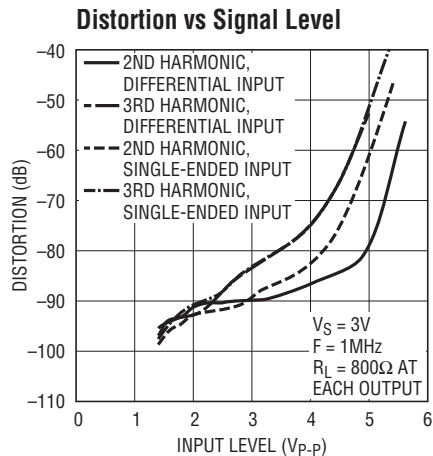
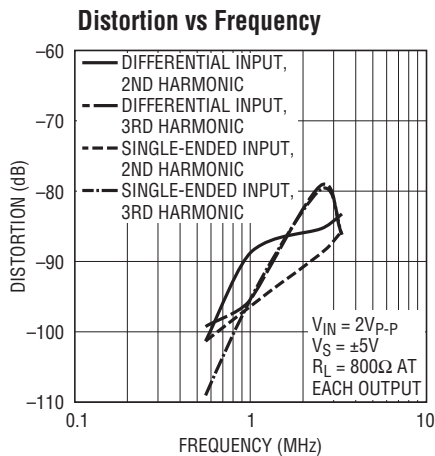
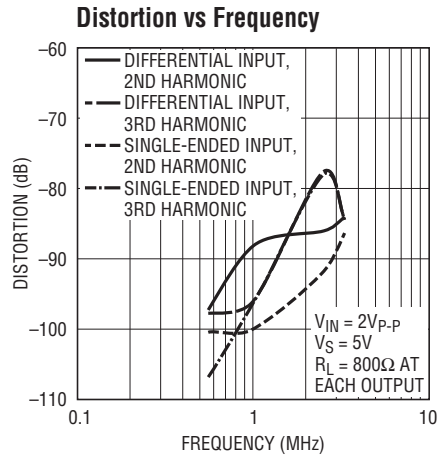
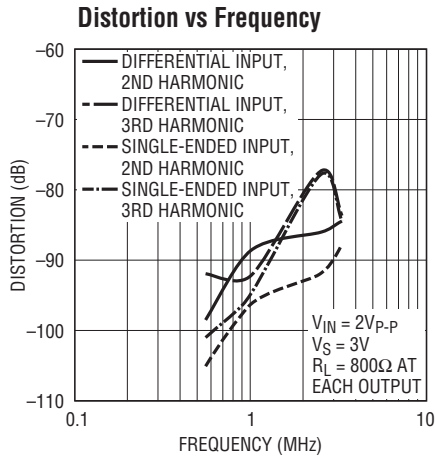

TYPICAL PERFORMANCE CHARACTERISTICS

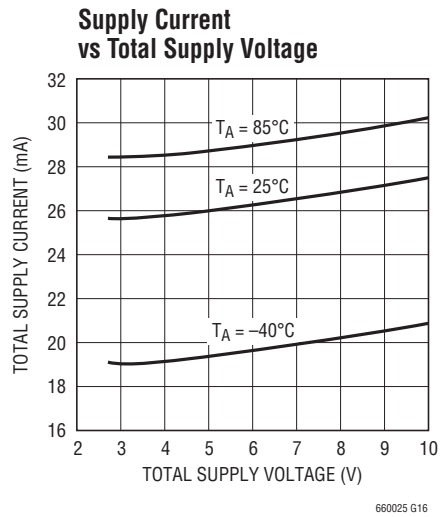
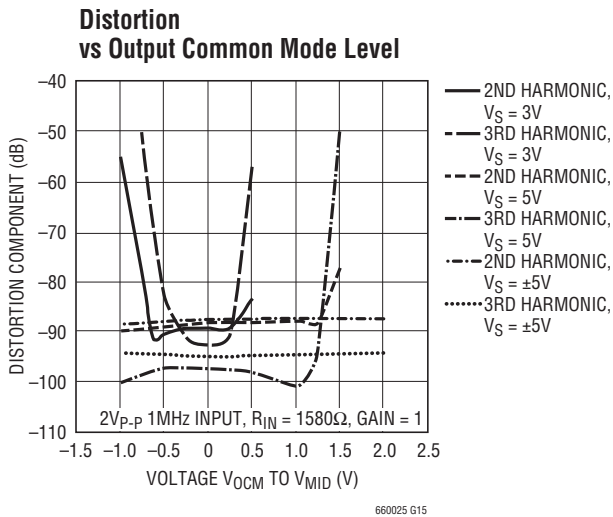
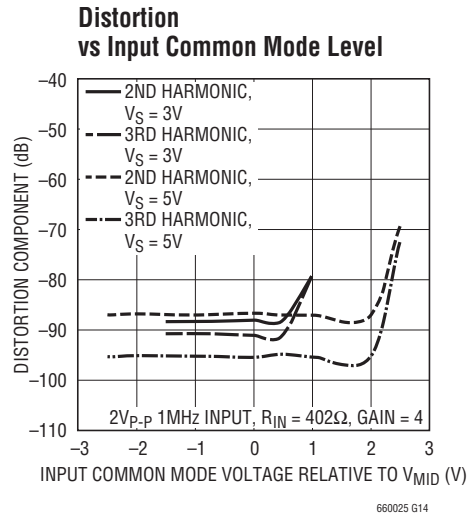
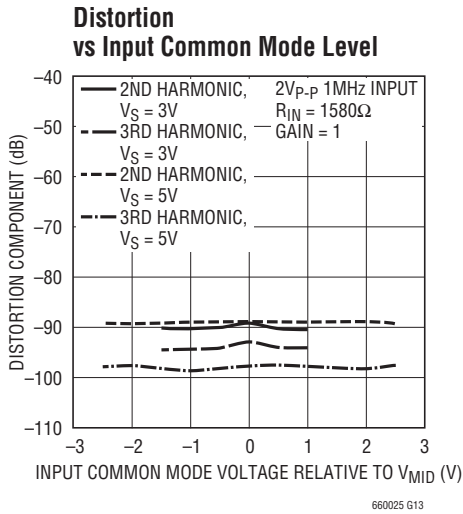

Transient Response Gain = 1

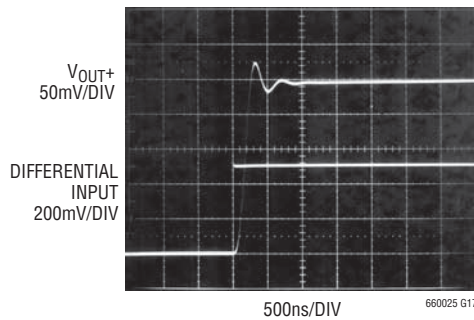

PIN FUNCTIONS (DFN/SO)

IN⁻ and IN⁺ (Pins 1, 12/Pins 1, 8): Input Pins. Signals can be applied to either or both input pins through identical external resistors, R_{IN}. The DC gain from differential inputs to the differential outputs is 1580Ω/R_{IN}.

NC (Pins 2, 5, 11/NA): No Connection

V_{OCM} (Pin 3/Pin 2): DC Common Mode Reference Voltage for the 2nd Filter Stage. Its value programs the common mode voltage of the differential output of the filter. This is a high impedance input, which can be driven from an external voltage reference, or it can be tied to V_{MID} on the PC board. V_{OCM} should be bypassed with a 0.01μF ceramic capacitor unless it is connected to a ground plane.

V⁺ and V⁻ (Pins 4, 8, 9/Pins 3, 6): Power Supply Pins. For a single 3.3V or 5V supply (V⁻ grounded) a quality 0.1μF ceramic bypass capacitor is required from the positive supply pin (V⁺) to the negative supply pin (V⁻). The bypass

should be as close as possible to the IC. For dual supply applications, bypass V⁺ to ground and V⁻ to ground with a quality 0.1μF ceramic capacitor.

OUT⁺ and OUT⁻ (Pins 6, 7/Pins 4, 5): Output Pins. These are the filter differential outputs. Each pin can drive a 100Ω and/or 50pF load to AC ground.

V_{MID} (Pin 10/Pin 7): The V_{MID} pin is internally biased at mid-supply, see Block Diagram. For single supply operation, the V_{MID} pin should be bypassed with a quality 0.01μF ceramic capacitor to V⁻. For dual supply operation, V_{MID} can be bypassed or connected to a high quality DC ground. A ground plane should be used. A poor ground will increase noise and distortion. V_{MID} sets the output common mode voltage of the 1st stage of the filter. It has a 5.5kΩ impedance, and it can be overridden with an external low impedance voltage source.

BLOCK DIAGRAM

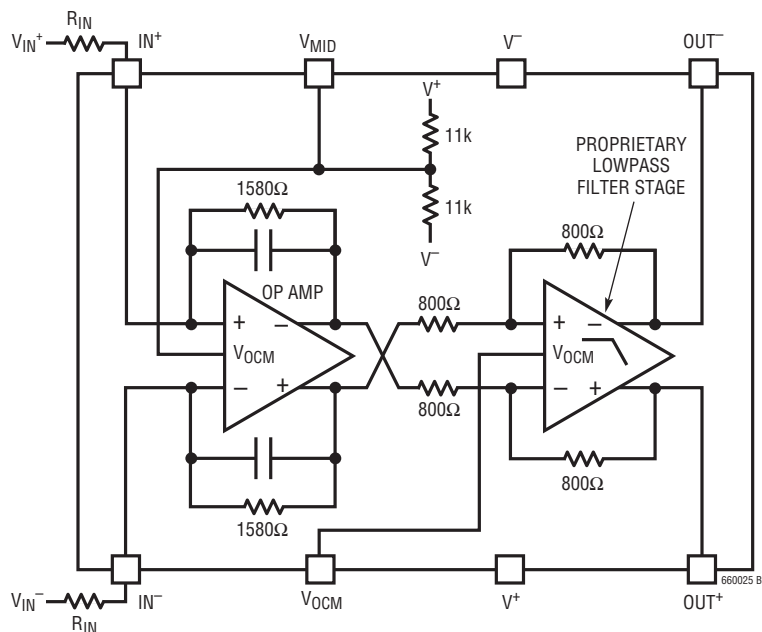

APPLICATIONS INFORMATION

Interfacing to the LT6600-2.5

Note: The referenced pin numbers correspond to the S8 package. See the Pin Functions for the equivalent DFN-12 package pin numbers.

The LT6600-2.5 requires two equal external resistors, R_{IN} , to set the differential gain to $1580\Omega/R_{IN}$. The inputs to the filter are the voltages V_{IN}^+ and V_{IN}^- presented to the see external components, Figure 1. The difference between V_{IN}^+ and V_{IN}^- is the differential input voltage. The average of V_{IN}^+ and V_{IN}^- is the common mode input voltage. Similarly, the voltages V_{OUT}^+ and V_{OUT}^- appearing at Pins 4 and 5 of the LT6600-2.5 are the filter outputs. The difference between V_{OUT}^+ and V_{OUT}^- is the differential output voltage. The average of V_{OUT}^+ and V_{OUT}^- is the common mode output voltage.

Figure 1 illustrates the LT6600-2.5 operating with a single 3.3V supply and unity passband gain; the input signal is

DC-coupled. The common mode input voltage is 0.5V, and the differential input voltage is $2V_{P-P}$. The common mode output voltage is 1.65V, and the differential output voltage is $2V_{P-P}$ for frequencies below 2.5MHz. The common mode output voltage is determined by the voltage at V_{OCM} . Since V_{OCM} is shorted to V_{MID} , the output common mode is the mid-supply voltage. In addition, the common mode input voltage can be equal to the mid-supply voltage of V_{MID} .

Figure 2 shows how to AC couple signals into the LT6600-2.5. In this instance, the input is a single-ended signal. AC-coupling allows the processing of single-ended or differential signals with arbitrary common mode levels. The $0.1\mu F$ coupling capacitor and the 1580Ω gain setting resistor form a highpass filter, attenuating signals below 1kHz. Larger values of coupling capacitors will proportionally reduce this highpass 3dB frequency.

In Figure 3 the LT6600-2.5 is providing 12dB of gain. The common mode output voltage is set to 2V.

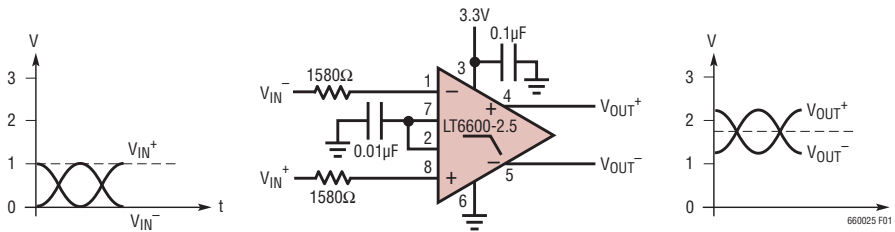

Figure 1. (S8 Pin Numbers)

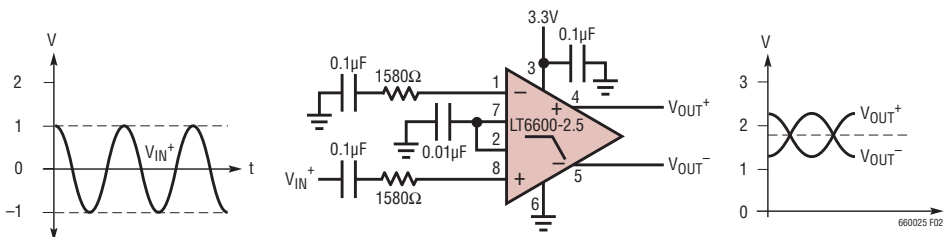

Figure 2. (S8 Pin Numbers)

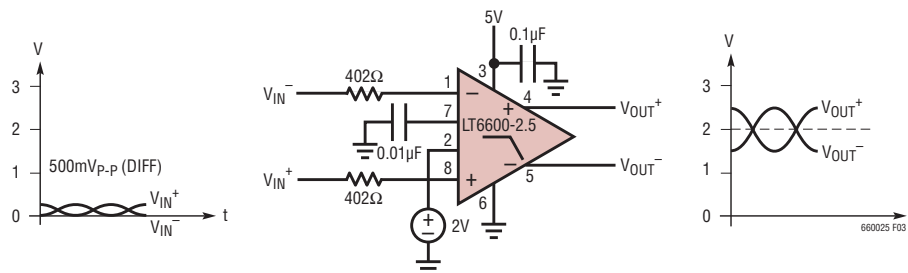

Figure 3. (S8 Pin Numbers)

APPLICATIONS INFORMATION

Use Figure 4 to determine the interface between the LT6600-2.5 and a current output DAC. The gain, or “transimpedance,” is defined as $A = V_{OUT}/I_{IN}$. To compute the transimpedance, use the following equation:

$$A = \frac{1580 \cdot R1}{(R1 + R2)} (\Omega)$$

By setting $R1 + R2 = 1580\Omega$, the gain equation reduces to $A = R1(\Omega)$.

The voltage at the pins of the DAC is determined by $R1$, $R2$, the voltage on V_{MID} and the DAC output current. Consider Figure 4 with $R1 = 49.9\Omega$ and $R2 = 1540\Omega$. The voltage at V_{MID} , for $V_S = 3.3V$, is 1.65V. The voltage at the DAC pins is given by:

$$\begin{aligned} V_{DAC} &= V_{PIN7} \cdot \frac{R1}{R1 + R2 + 1580} + I_{IN} \cdot \frac{R1 \cdot R2}{R1 + R2} \\ &= 26mV + I_{IN} \cdot 48.3\Omega \end{aligned}$$

I_{IN} is I_{IN}^+ or I_{IN}^- . The transimpedance in this example is 49.6Ω .

Evaluating the LT6600-2.5

The low impedance levels and high frequency operation of the LT6600-2.5 require some attention to the matching networks between the LT6600-2.5 and other devices. The previous examples assume an ideal (0Ω) source impedance and a large ($1k\Omega$) load resistance. Among practical examples where impedance must be considered is the evaluation of the LT6600-2.5 with a network analyzer.

Figure 5 is a laboratory setup that can be used to characterize the LT6600-2.5 using single-ended instruments with 50Ω source impedance and 50Ω input impedance. For a 12dB gain configuration the LT6600-2.5 requires a 402Ω source resistance yet the network analyzer output is calibrated for a 50Ω load resistance. The 1:1 transformer, 53.6Ω and 388Ω resistors satisfy the two constraints above. The transformer converts the single-ended source into a differential stimulus. Similarly, the output of the LT6600-2.5 will have lower distortion with larger load resistance yet the analyzer input is typically 50Ω . The 4:1 turns (16:1 impedance) transformer and the two 402Ω resistors of Figure 5, present the output of the LT6600-2.5 with a 1600Ω differential load, or the equivalent of 800Ω to ground at each output. The impedance seen by the network analyzer input is still 50Ω , reducing reflections in the cabling between the transformer and analyzer input.

Differential and Common Mode Voltage Ranges

The rail-to-rail output stage of the LT6600-2.5 can process large differential signal levels. On a 3V supply, the output signal can be $5.1V_{P-P}$. Similarly, a 5V supply can support signals as large as $8.8V_{P-P}$. To prevent excessive power dissipation in the internal circuitry, the user must limit differential signal levels to $9V_{P-P}$.

The two amplifiers inside the LT6600-2.5 have independent control of their output common mode voltage (see the Block Diagram section). The following guidelines will optimize the performance of the filter.

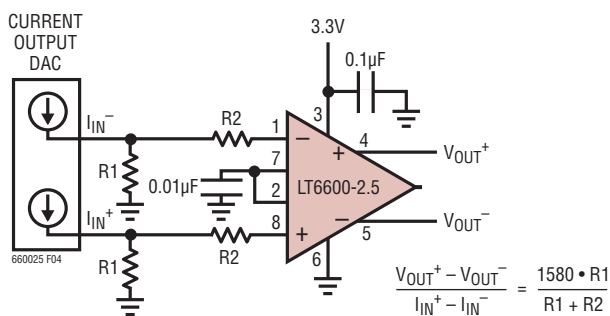

Figure 4. (S8 Pin Numbers)

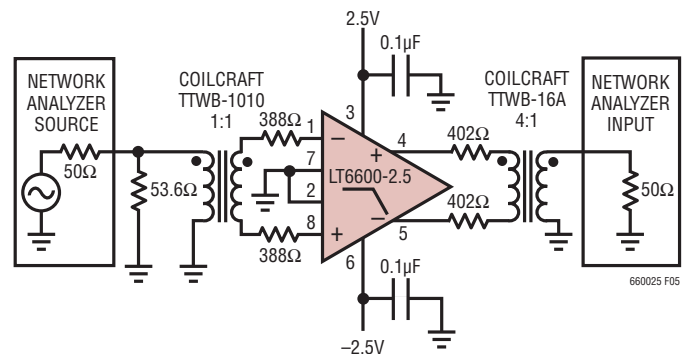

Figure 5. (S8 Pin Numbers)

APPLICATIONS INFORMATION

V_{MID} can be allowed to float, but it must be bypassed to an AC ground with a $0.01\mu\text{F}$ capacitor or some instability may be observed. V_{MID} can be driven from a low impedance source, provided it remains at least 1.5V above V^- and at least 1.5V below V^+ . An internal resistor divider sets the voltage of V_{MID} . While the internal 11k resistors are well matched, their absolute value can vary by $\pm 20\%$. This should be taken into consideration when connecting an external resistor network to alter the voltage of V_{MID} .

V_{OCM} can be shorted to V_{MID} for simplicity. If a different common mode output voltage is required, connect V_{OCM} to a voltage source or resistor network. For 3V and 3.3V supplies the voltage at V_{OCM} must be less than or equal to the mid-supply level. For example, voltage (V_{OCM}) $\leq 1.65\text{V}$ on a single 3.3V supply. For power supply voltages higher than 3.3V the voltage at V_{OCM} can be set above mid-supply, as shown in Table 1. The voltage on V_{OCM} should not exceed 1V below the voltage on V_{MID} . V_{OCM} is a high impedance input.

Table 1. Output Common Range for Various Supplies

SUPPLY VOLTAGE	DIFFERENTIAL OUT VOLTAGE SWING	OUTPUT COMMON MODE RANGE FOR LOW DISTORTION
3V	4V _{P-P}	$1.4\text{V} \leq V_{OCM} \leq 1.6\text{V}$
	2V _{P-P}	$1\text{V} \leq V_{OCM} \leq 1.6\text{V}$
	1V _{P-P}	$0.75\text{V} \leq V_{OCM} \leq 1.6\text{V}$
5V	8V _{P-P}	$2.4\text{V} \leq V_{OCM} \leq 2.6\text{V}$
	4V _{P-P}	$1.5\text{V} \leq V_{OCM} \leq 3.5\text{V}$
	2V _{P-P}	$1\text{V} \leq V_{OCM} \leq 3.75\text{V}$
$\pm 5\text{V}$	1V _{P-P}	$0.75\text{V} \leq V_{OCM} \leq 3.75\text{V}$
	9V _{P-P}	$-2\text{V} \leq V_{OCM} \leq 2\text{V}$
	4V _{P-P}	$-3.5\text{V} \leq V_{OCM} \leq 3.5\text{V}$
	2V _{P-P}	$-3.75\text{V} \leq V_{OCM} \leq 3.75\text{V}$
	1V _{P-P}	$-4.25\text{V} \leq V_{OCM} \leq 3.75\text{V}$

NOTE: V_{OCM} is set by the voltage at this R_{IN} . The voltage at V_{OCM} should not exceed 1V below the voltage at V_{MID} . To achieve some of the output common mode ranges shown in the table, the voltage at V_{MID} must be set externally to a value below mid supply.

The LT6600-2.5 was designed to process a variety of input signals including signals centered around the mid-supply voltage and signals that swing between ground and a positive voltage in a single supply system (Figure 1). The range of allowable input common mode voltage (the average of V_{IN}^+ and V_{IN}^- in Figure 1) is determined by the power supply level and gain setting (see Electrical Characteristics).

Common Mode DC Currents

In applications like Figure 1 and Figure 3 where the LT6600-2.5 not only provides lowpass filtering but also level shifts the common mode voltage of the input signal, DC currents will be generated through the DC path between input and output terminals. Minimize these currents to decrease power dissipation and distortion.

Consider the application in Figure 3. V_{MID} sets the output common mode voltage of the 1st differential amplifier inside the LT6600-2.5 (see the Block Diagram section) at 2.5V . Since the input common mode voltage is near 0V , there will be approximately a total of 2.5V drop across the series combination of the internal 1580Ω feedback resistor and the external 402Ω input resistor. The resulting 1.25mA common mode DC current in each input path, must be absorbed by the sources V_{IN}^+ and V_{IN}^- . V_{OCM} sets the common mode output voltage of the 2nd differential amplifier inside the LT6600-2.5, and therefore sets the common mode output voltage of the filter. Since, in the example of Figure 3, V_{OCM} differs from V_{MID} by 0.5V , an additional $625\mu\text{A}$ ($312\mu\text{A}$ per side) of DC current will flow in the resistors coupling the 1st differential amplifier output stage to filter output. Thus, a total of 3.125mA is used to translate the common mode voltages.

A simple modification to Figure 3 will reduce the DC common mode currents by 36% . If V_{MID} is shorted to V_{OCM} the common mode output voltage of both op amp stages will be 2V and the resulting DC current will be 2mA . Of course, by AC-coupling the inputs of Figure 3, the common mode DC current can be reduced to $625\mu\text{A}$.

APPLICATIONS INFORMATION

Noise

The noise performance of the LT6600-2.5 can be evaluated with the circuit of Figure 6.

Given the low noise output of the LT6600-2.5 and the 6dB attenuation of the transformer coupling network, it will be necessary to measure the noise floor of the spectrum analyzer and subtract the instrument noise from the filter noise measurement.

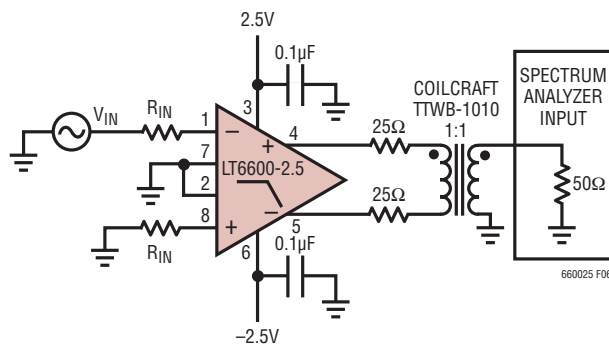

Figure 6. (S8 Pin Numbers)

Example: With the IC removed and the 25Ω resistors grounded, Figure 6, measure the total integrated noise (e_S) of the spectrum analyzer from 10kHz to 2.5MHz. With the IC inserted, the signal source (V_{IN}) disconnected, and the input resistors grounded, measure the total integrated noise out of the filter (e_0). With the signal source connected, set the frequency to 100kHz and adjust the amplitude until V_{IN} measures 100mV_{p-p}. Measure the output amplitude, V_{OUT} , and compute the passband gain $A = V_{OUT}/V_{IN}$. Now compute the input referred integrated noise (e_{IN}) as:

$$e_{IN} = \frac{\sqrt{(e_0)^2 - (e_S)^2}}{A}$$

Table 2 lists the typical input referred integrated noise for various values of R_{IN} .

Table 2. Noise Performance

PASSBAND GAIN (V/V)	R_{IN}	INPUT REFERRED INTEGRATED NOISE 10kHz TO 2.5MHz	INPUT REFERRED INTEGRATED NOISE 10kHz TO 5MHz
4	402Ω	18µV _{RMS}	23µV _{RMS}
2	806Ω	29µV _{RMS}	39µV _{RMS}
1	1580Ω	51µV _{RMS}	73µV _{RMS}

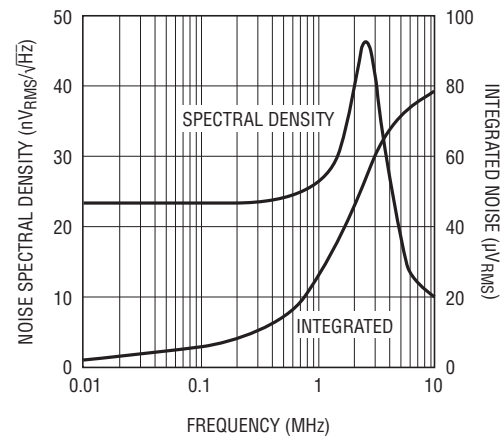

Figure 7. Input Referred Noise, Gain = 1

Figure 7 is plot of the noise spectral density as a function of frequency for an LT6600-2.5 with $R_{IN} = 1580\Omega$ using the fixture of Figure 6 (the instrument noise has been subtracted from the results).

The noise at each output is comprised of a differential component and a common mode component. Using a transformer or combiner to convert the differential outputs to single-ended signal rejects the common mode noise and gives a true measure of the S/N achievable in the system. Conversely, if each output is measured individually and the noise power added together, the resulting calculated noise level will be higher than the true differential noise.

Power Dissipation

The LT6600-2.5 amplifiers combine high speed with large-signal currents in a small package. There is a need to ensure that the die's junction temperature does not exceed 150°C. The LT6600-2.5 S8 package has Pin 6 fused to the lead frame to enhance thermal conduction when connecting to a ground plane or a large metal trace. Metal trace and plated through-holes can be used to spread the heat generated by the device to the backside of the PC board. For example, on a 3/32" FR-4 board with 2oz copper, a total of 660 square millimeters connected to Pin 6 of the LT6600-2.5 S8 (330 square millimeters on each side of the PC board) will result in a thermal resistance, θ_{JA} , of about 85°C/W. Without the extra metal trace connected to

APPLICATIONS INFORMATION

the V^- pin to provide a heat sink, the thermal resistance will be around 105°C/W. Table 3 can be used as a guide when considering thermal resistance.

Table 3. LT6600-2.5 SO-8 Package Thermal Resistance

COPPER AREA		BOARD AREA (mm ²)	THERMAL RESISTANCE (JUNCTION-TO-AMBIENT)
TOPSIDE (mm ²)	BACKSIDE (mm ²)		
1100	1100	2500	65°C/W
330	330	2500	85°C/W
35	35	2500	95°C/W
35	0	2500	100°C/W
0	0	2500	105°C/W

Junction temperature, T_J , is calculated from the ambient-temperature, T_A , and power dissipation, P_D . The power dissipation is the product of supply voltage, V_S , and supply current, I_S . Therefore, the junction temperature is given by:

$$T_J = T_A + (P_D \cdot \theta_{JA}) = T_A + (V_S \cdot I_S \cdot \theta_{JA})$$

where the supply current, I_S , is a function of signal level, load impedance, temperature and common mode voltages.

For a given supply voltage, the worst-case power dissipation occurs when the differential input signal is maximum, the common mode currents are maximum (see Applications Information regarding Common Mode DC Currents), the load impedance is small and the ambient temperature is maximum. To compute the junction temperature, measure the supply current under these worst-case conditions, estimate the thermal resistance from Table 2, then apply the equation for T_J . For example, using the circuit in Figure 3 with DC differential input voltage of 1V, a differential output voltage of 4V, no load resistance and an ambient temperature of 85°C, the supply current (current into V^+) measures 37.6mA. Assuming a PC board layout with a 35mm² copper trace, the θ_{JA} is 100°C/W. The resulting junction temperature is:

$$T_J = T_A + (P_D \cdot \theta_{JA}) = 85 + (5 \cdot 0.0376 \cdot 100) = 104^\circ\text{C}$$

When using higher supply voltages or when driving small impedances, more copper may be necessary to keep T_J below 150°C.

PACKAGE DESCRIPTION

DF Package
12-Lead Plastic DFN (4mm × 4mm)
 (Reference LTC DWG # 05-08-1733 Rev 0)

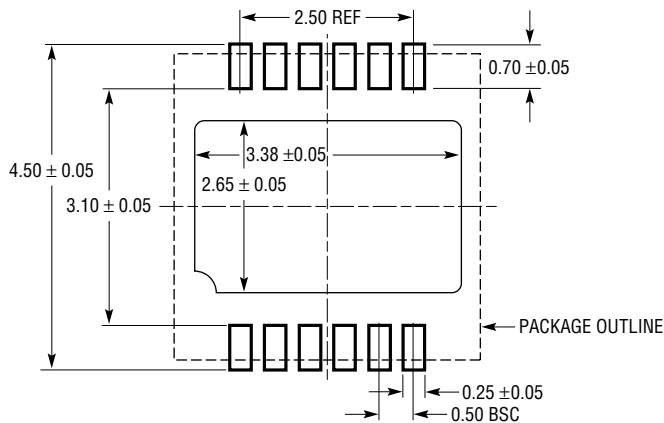

RECOMMENDED SOLDER PAD PITCH AND DIMENSIONS
 APPLY SOLDER MASK TO AREAS THAT ARE NOT SOLDERED

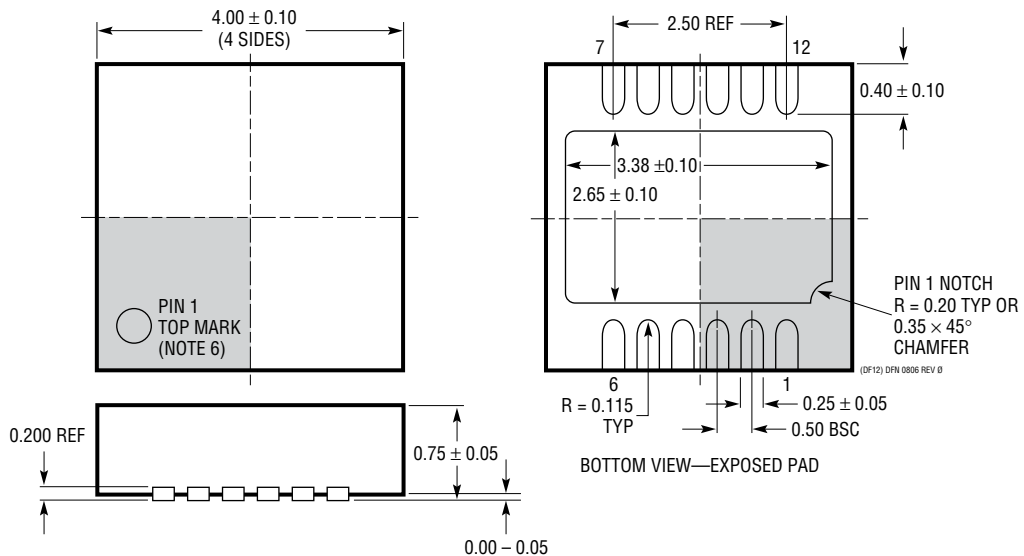

NOTE:

1. DRAWING IS PROPOSED TO BE MADE A JEDEC PACKAGE OUTLINE MO-220 VARIATION (WGGD-X)—TO BE APPROVED
2. DRAWING NOT TO SCALE
3. ALL DIMENSIONS ARE IN MILLIMETERS
4. DIMENSIONS OF EXPOSED PAD ON BOTTOM OF PACKAGE DO NOT INCLUDE MOLD FLASH. MOLD FLASH, IF PRESENT, SHALL NOT EXCEED 0.15mm ON ANY SIDE
5. EXPOSED PAD SHALL BE SOLDER PLATED
6. SHADED AREA IS ONLY A REFERENCE FOR PIN 1 LOCATION ON THE TOP AND BOTTOM OF PACKAGE

PACKAGE DESCRIPTION

S8 Package
8-Lead Plastic Small Outline (Narrow .150 Inch)
 (Reference LTC DWG # 05-08-1610)

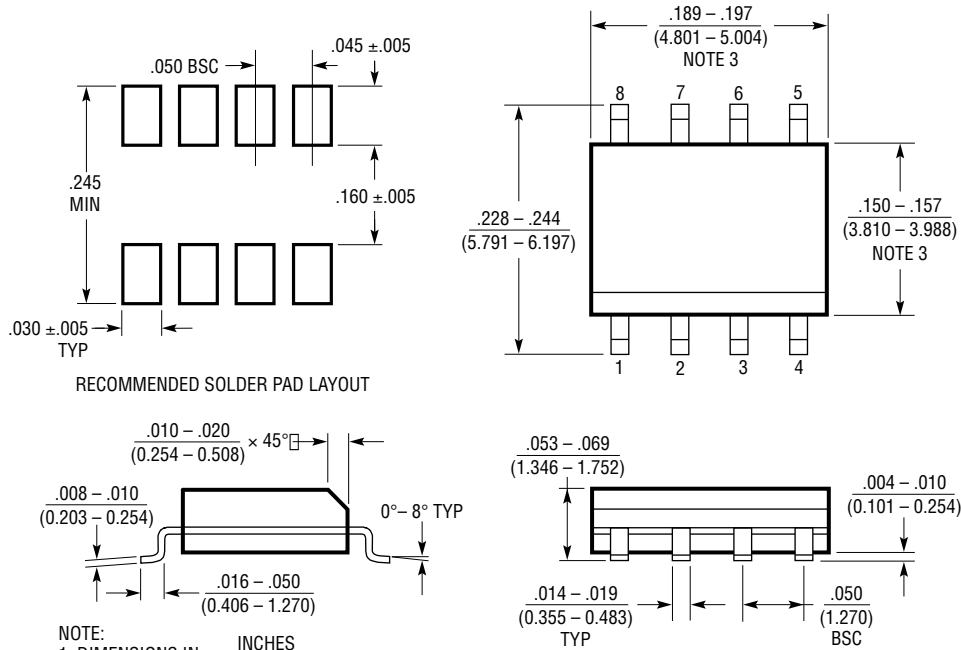

- NOTE:
 1. DIMENSIONS IN INCHES (MILLIMETERS)
 2. DRAWING NOT TO SCALE
 3. THESE DIMENSIONS DO NOT INCLUDE MOLD FLASH OR PROTRUSIONS. MOLD FLASH OR PROTRUSIONS SHALL NOT EXCEED $.006"$ (0.15mm)

S08 0303

REVISION HISTORY (Revision history begins at Rev E)

REV	DATE	DESCRIPTION	PAGE NUMBER
E	5/10	Updated Order Information section	2

TYPICAL APPLICATION

5th Order Lowpass Filter (S8 Pin Numbers Shown)

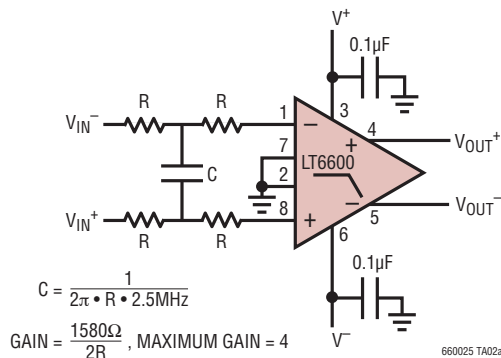

Amplitude Response

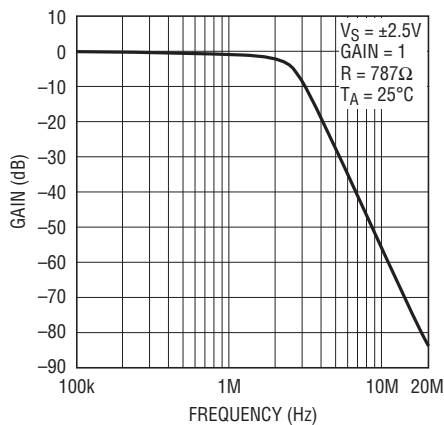

Transient Response Gain = 1

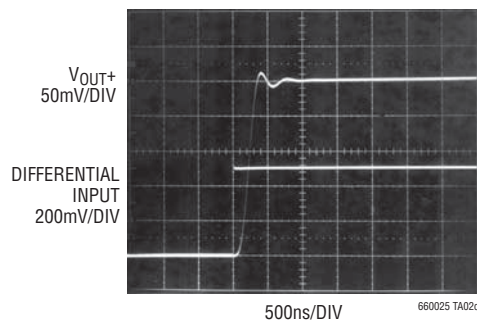

RELATED PARTS

PART NUMBER	DESCRIPTION	COMMENTS
LTC [®] 1565-31	650kHz Linear Phase Lowpass Filter	Continuous Time, SO8 Package, Fully Differential
LTC1566-1	Low Noise, 2.3MHz Lowpass Filter	Continuous Time, SO8 Package
LT1567	Very Low Noise, High Frequency Filter Building Block	1.4nV/√Hz Op Amp, MSOP Package, Fully Differential
LT1568	Very Low Noise, 4th Order Building Block	Lowpass and Bandpass Filter Designs Up to 10MHz, Differential Outputs
LTC1992	Low-Power Differential In/Out Amplifier	Adjustable Gain, MSOP Package
LTC1992-1	Low-Power Differential In/Out Amplifier	Fixed Gain of 1, Matching ±0.3%
LTC1992-2	Low-Power Differential In/Out Amplifier	Fixed Gain of 2, Matching ±0.3%
LTC1992-5	Low-Power Differential In/Out Amplifier	Fixed Gain of 5, Matching ±0.3%
LTC1992-10	Low-Power Differential In/Out Amplifier	Fixed Gain of 10, Matching ±0.3%
LT6600-10	Very Low Noise Differential Amplifier and 10MHz Lowpass Filter	82dB S/N with 3V Supply, SO-8 Package
LT6600-20	Very Low Noise Differential Amplifier and 20MHz Lowpass Filter	76dB S/N with 3V Supply, SO-8 Package